



**SCIENTIFIC COMMITTEE**  
**FIFTEENTH REGULAR SESSION**  
Pohnpei, Federated States of Micronesia  
12–20 August 2019

---

Mixed fishery and multi-species issues in harvest strategy evaluations.

---

WCPFC-SC15-2019/MI-WP-04

F. Scott<sup>1</sup>, R. Scott, N. Yao, G. M. Pilling and J. Hampton

---

<sup>1</sup>Oceanic Fisheries Programme, The Pacific Community

# Contents

<b>1</b>	<b>Introduction</b>	<b>5</b>
<b>2</b>	<b>Mixed fisheries overview</b>	<b>5</b>
<b>3</b>	<b>Considering mixed fishery interactions in the harvest strategy evaluations</b>	<b>7</b>
3.1	Fully integrated approach . . . . .	7
3.2	Hierarchical approach . . . . .	9
<b>4</b>	<b>Discussion</b>	<b>14</b>
<b>A</b>	<b>Distribution of catches and fisheries for the four tuna stocks</b>	<b>18</b>
<b>B</b>	<b>Impact of fisheries on the four tuna stocks</b>	<b>20</b>

## Executive Summary

WCPFC12 agreed to a workplan for the adoption of harvest strategies for WCPO skipjack, bigeye, yellowfin tuna and South Pacific albacore. These four tuna stocks are caught by an overlapping mix of fisheries. Management measures aimed at one particular stock can therefore have impacts on other stocks. An important consideration when developing harvest strategies is how to account for mixed fishery interactions.

This report describes three potential approaches for modeling mixed fisheries in the WCPO harvest strategy evaluations, which have different levels of technical complexity. While we raise some issues that require management consideration within the paper, we suggest these require WCPFC16 consideration and hence our focus in this paper is on the technical issues for SC15.

We identify two potential options for modelling mixed fisheries in the harvest strategy evaluations:

1. **Fully integrated modelling approach** that attempts to capture all the mixed fisheries considerations in a single framework and uses multi-species management procedures (MPs). We note that this approach has significant technical overheads.

2. **Hierarchical approach** that develops prospective single-stock MPs for skipjack, South Pacific albacore and bigeye tuna, for direct application to all relevant fisheries impacting those stocks. A key feature of this approach is that management of the major fisheries – purse seine, tropical and northern longline and southern longline – will each be driven by one focal species-based MP – skipjack in the case of purse seine, bigeye in the case of tropical and northern longline, and South Pacific albacore in the case of southern longline. Therefore, the management settings for these fisheries will be determined by the application of MPs that consider the stock status of the respective focal species only. This is consistent with the staged approach of the harvest strategy work plan agreed by WCPFC. However, some interaction among the MPs will be required to fully incorporate the impacts of all fisheries. For example, the bigeye tuna MP will need to consider the impact of the purse seine fisheries, the southern longline fishery and others on the bigeye stock. The activity of these fisheries in the relevant regions of the bigeye model can be taken from the skipjack and South Pacific albacore MP evaluations, respectively, using a method similar to that employed for the tropical tuna Conservation and Management Measures (CMM2018-01) evaluations. Likewise, the South Pacific albacore MP will also need to consider the impacts on albacore of the tropical longline fishery south of the Equator, the albacore catches of which would depend on the settings of the bigeye MP for that fishery. Under this approach, yellowfin tuna does not have a dedicated species-based MP. Rather, the impact on yellowfin tuna would be evaluated from the application of the combined MPs for skipjack, bigeye and South Pacific albacore to all fisheries that significantly impact yellowfin. This framework would be used to identify those MP combinations that have an acceptably high chance of achieving management objectives for all stocks, including yellowfin. While the hierarchical approach does not fully capture mixed fishery/mixed species interactions in an integrated framework (which would require multi-species MPs), it provides an initial step to

pursuing the further development of harvest strategies, highlighting potential areas for subsequent management focus and informing future model development.

We invite WCPFC-SC15 to:

- Consider the technical issues involved in evaluating multi-species/multi-fleet management procedures in the WCPO;
- Consider the above alternative approaches and recommend a preferred approach.

# 1 Introduction

At the twelfth regular session of the Western and Central Pacific Fisheries Commission (WCPFC), the Commission agreed to a workplan for the adoption of harvest strategies for Western and Central Pacific Ocean (WCPO) skipjack, bigeye, yellowfin tuna and South Pacific albacore (WCPFC, 2015). These four tuna stocks are caught by an overlapping mix of fisheries with different gears in overlapping regions (see Figures 3, 4, 5 and 6 in Appendix A). These mixed fishery interactions can have an impact on fisheries management because management measures aimed at one particular stock can have impacts on other stocks. This means that it may not be appropriate to consider the management of individual stocks in isolation and instead it may be necessary to consider the management of multiple stocks in a common framework. For example, bigeye and yellowfin are caught in the tropical longline fishery (amongst other fisheries) which means that management of bigeye through controls on tropical longline would also have an impact on yellowfin. Therefore, an important consideration when developing harvest strategies is how to account for mixed fishery interactions. In particular, it is necessary to decide which fisheries and stocks should be included and how fishing opportunities for the fisheries are set.

This report:

- Summarises the mixed fishery interactions of skipjack, South Pacific albacore, bigeye and yellowfin tuna in the WCPO;
- Describes two technical approaches for modeling, and ultimately managing, mixed fisheries in the harvest strategy evaluations.

## 2 Mixed fisheries overview

Within the WCPO region, the mixed fishery interactions between fisheries and species are complicated, with multiple species being caught by multiple gears (Figure 1).

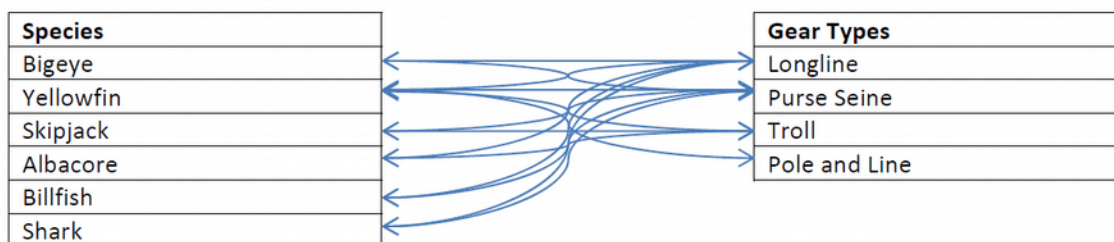

Figure 1: Interactions of gear types and species in the WCPO region (from: Norris et al. (2013)).

The extent of the mixed fishery interactions for the four tuna stocks can be seen by calculating the proportion of average catch by weight (2015-2017). For the purposes of this report, tropical

longline catches of South Pacific albacore are from the equator to 10° South and of the other stocks from 20° North to 10° South. Southern longline catches are from south of 10° South. Northern longline catches are from 20° North to 50° North. Purse seine, pole and line and other catches are from south of 50° North.

	Tropical longline	Southern longline	Northern longline	Pole and line	Purse seine	Other
SP Albacore	0.14	0.82	0	0	0	0.04
Bigeye	0.33	0.05	0.08	0.03	0.41	0.10
Skipjack	0	0	0	0.09	0.80	0.11
Yellowfin	0.09	0.03	0.01	0.04	0.63	0.20

Table 1: Proportion of average catch by weight (2015-2017) by stock.

From a stock perspective, South Pacific albacore is predominantly caught by the longline fisheries ( $\sim 96\%$ ), particularly southern longline; skipjack are predominantly caught by purse seine fisheries ( $\sim 80\%$ ); bigeye are mainly caught by a mix of longline (mainly tropical longline) and purse seine fisheries; and yellowfin are mainly caught by purse seine but are also caught by longline and 'other' fisheries (Table 1).

	SP Albacore	Bigeye	Skipjack	Yellowfin
Tropical longline	0.09	0.41	0.02	0.48
Southern longline	0.66	0.09	0.01	0.24
Northern longline	0	0.64	0.01	0.35
Pole and line	0.00	0.02	0.84	0.14
Purse seine	0.00	0.03	0.75	0.22
Other	0.01	0.04	0.59	0.36

Table 2: Proportion of average catch by weight (2015-2017) by fishery.

From a fishery perspective, longline fisheries catch a mix of South Pacific albacore, bigeye and yellowfin; pole and line fisheries mainly catch skipjack (although the proportion of total skipjack taken by pole and line is small) with some yellowfin; purse seine fisheries mainly catch skipjack and also some yellowfin; and 'other' fisheries mainly catch skipjack and yellowfin (Table 2).

With regards the longline fishery component, catches of bigeye by southern longline are small compared to that of the tropical longline. Yellowfin longline catches mostly come from the tropical longline fishery with about a quarter coming from the southern longline, where along with bigeye they form an important economic component of the catch (Pilling et al., 2016).

The impact of different fisheries on the stocks are shown in Appendix B. Skipjack is predominantly impacted by associated and free-school purse seine fisheries (Figure 7), while South Pacific albacore is predominantly impacted by the southern longline fishery (Figure 8, noted as sub-tropical longline in the figure). Bigeye is mainly impacted by the associated purse seine fishery (the impact of free-school purse seine fishery is small) as well as longline fisheries (Figure 9). Yellowfin is impacted by a mix of fisheries including associated and free-school purse seine and 'other' fisheries (Figure 9).

### 3 Considering mixed fishery interactions in the harvest strategy evaluations

Including mixed fishery interactions in a harvest strategy can be challenging. The agreed WCPFC harvest strategy work plan recognised this and proposed the initial focus on skipjack, followed by South Pacific albacore, and then bigeye and yellowfin. This is because skipjack and South Pacific albacore are mainly caught by a single dominant fishery (purse seine and southern longline respectively) and so single stock evaluations could initially be developed. The experience of developing these initial evaluations would then inform subsequent model development. Initial evaluations that include bigeye and yellowfin are thought to be more challenging as they include mixed fisheries considerations as shown above.

A key component of a harvest strategy is the management procedure (MP). This is a combination of data collection, the estimation method (the approach used to monitor stock status and provide the signal for management action), and a decision rule, known as a harvest control rule (HCR), that sets fishing opportunities based on the estimates of stock status (Punt et al., 2014). An MP is adopted on the basis that it provides the best option for achieving the agreed management objectives. Before an MP is adopted, the relative performance of candidate MPs, including the robustness to uncertainty, can be tested using Management Strategy Evaluation (MSE) (Punt et al., 2014; Scott et al., 2018a).

In this section we describe two potential approaches for developing the MSE framework, which have different levels of technical complexity. Moving from the most complex to the least, we discuss the pros and cons and suggest a preferred approach for further consideration. While we raise some issues that require management consideration, we suggest these are a focus for WCPFC16 consideration and hence focus on the technical issues for SC15.

#### 3.1 Fully integrated approach

Given the mixed fishery interactions described above, ideally the four tuna stocks would be included in a single integrated evaluation framework. This framework would include a single MP that incorporates the status of all four stocks and sets fishing opportunities for all fisheries. However, there are many challenges in developing such a multi-species, multi-fishery evaluation framework.

The MPs would potentially be very complicated. For example, there would need to be an estimation method for each stock that might feed into multiple HCRs that define the future fishing level of each of the fisheries being controlled. Additionally, given their complexity, it may be more challenging to communicate and agree a multi-species MP with stakeholders.

The MSE framework contains a model of the interactions between the biological stocks and the fishing fleets, known as the operating model (OM). A particular challenge for the fully integrated

approach is developing an OM that contains multiple stocks and fisheries and captures the mixed fishery interactions. It may be possible to use an existing fully multi-species modelling framework that includes multiple stocks and fisheries. Several options for this are available, such as the Atlantis model developed at CSIRO, Australia (Fulton et al., 2011). However, there are many potential drawbacks for using such a model as part of the OM. They can be extremely complicated to set up and hard to parameterise, potentially increasing uncertainty in the model outputs. For example, the Atlantis model considers all parts of the marine ecosystem as well as a three dimensional biogeochemical model. Using such models for projections requires many assumptions about the state of the future to be made which further increases the uncertainty. Additionally, the size and complexity of the models can make them very slow to run, a significant consideration when evaluating multiple MPs across a range of uncertainties. Although such models have been successfully used as part of MSE frameworks, the case studies have tended to focus on smaller and more geographically constrained fisheries, which minimises those issues. At the scale of the WCPO, however, the technical challenges are significant.

A step down in complexity from the Atlantis-style model is the potential to use the existing WCPO stock assessments within a more integrated framework. The spatial and fishery structures of the WCPO stock assessments for the four tuna stocks have similarities. A modelling framework could therefore be developed that allows the impacts of key fishery changes on each stock to be evaluated (see below). This approach was used within the bio-economic modelling of the WCPO tuna fishery (Kirchner et al., 2014). That model used the 2012/2014 stock assessment models as the basis of the biological dynamics and that of the four key fisheries considered (tropical longline, southern longline, purse seine associated and purse seine unassociated).

The bio-economic modelling assumed different constant fishery levels into the future, and hence did not incorporate the feedback loop required for MSE modelling. While the integrated modelling framework could be re-developed in this fashion, and the feedback process incorporated, this would extend the modelling time of any (set of) MPs considerably. We also note that this approach, while capturing the fishery interactions, does not formally capture biological/ecosystem interactions (e.g. predator/prey interactions). The associated MPs would be complicated as they would need to consider all relevant stocks and require assumptions to be made about the associated weight of each stock within the multi-species MP. Finally, there would need to be pre-agreement on allocation between the fisheries, for example f We note however that decisions on the management of archipelagic waters and territorial seas are the responsibility of the States concerned.or those that catch bigeye and possibly yellowfin.

The positives of this first approach include:

- Best captures the interactions between stocks and fishing gears.

However, there are several disadvantages to this approach, which include:

- The model development and management decisions are much more extensive and complex



than in other approaches;

- The approach is technically time consuming and would extend the harvest strategy work plan considerably;
- The increased biological complexity inherent in species interactions requires further assumptions on dynamics that may be better captured through alternative scenarios/assumptions, and which may increase uncertainty in results further;
- The model implicitly requires decisions on allocation which are complex and will extend the required period for modelling while allocation is debated;
- Multi-species MPs (HCRs) are challenging to agree.

### 3.2 Hierarchical approach

The hierarchical approach involves developing prospective single stock MPs for skipjack, South Pacific albacore and bigeye respectively. The impact of these MPs on yellowfin would then be evaluated using a combined evaluation framework. This modelling framework is different to the fully integrated modelling approach described above as it consists of single stock MPs, rather than multi-species MPs. As such it will be easier to develop. This approach is technically comparable to the underlying technical framework of the 'bioeconomic framework' discussed above, but does not include the multispecies MP considerations of the fully integrated approach.

Initial development of the harvest strategies has focussed on single stock MSE frameworks for skipjack (Scott et al., 2018a, 2019) and South Pacific albacore (Yao et al., 2019), given they are primarily caught by only a single dominant fishery (purse seine and southern longline respectively) and there is little in the way of mixed fishery interactions between them. This is consistent with the staged approach of the harvest strategy work plan agreed by WCPFC. Under the hierarchical approach it is proposed that a single stock MSE framework is also developed for bigeye in which the MP controls the tropical longline fisheries.

This single stock approach will need to consider the mixed-fishery interactions. For example, it will need to consider the impact of purse seine and southern longline fisheries on the bigeye stock. As well as the main fisheries discussed above, the impact of 'other' fisheries such as those in Indonesia, Philippines and Vietnam as well as in archipelagic waters and territorial seas need to be considered. An initial description of the interactions between the stocks, the proposed MPs for skipjack, South Pacific albacore and bigeye and the different fisheries can be seen in Table 3.

In this approach the skipjack MP is solely responsible for controlling the tropical purse seine fisheries (in bold in Table 3). The northern purse seine, pole and line and fisheries in Indonesia, Philippines and Vietnam could also be controlled by the skipjack MP, for example proportionate to the tropical purse seine over a specified base period, i.e. the northern purse seine effort could

Stock Fishery	Skipjack	Yellowfin	Bigeye	South Pacific Albacore
Tropical PS	<b>SKJ MP</b>	SKJ MP <sup>1</sup>	SKJ MP <sup>1</sup>	NA
Northern PS	SKJ MP <sup>1</sup>	SKJ MP <sup>1</sup>	SKJ MP <sup>1</sup>	NA
Tropical LL	NA	BET MP <sup>2</sup>	<b>BET MP</b>	BET MP <sup>1</sup>
Northern LL	NA	BET MP <sup>2</sup>	BET MP <sup>2</sup>	NA
Southern LL	NA	ALB MP <sup>3</sup>	ALB MP <sup>3</sup>	<b>ALB MP</b>
PL	SKJ MP <sup>1</sup>	SKJ MP <sup>1</sup>	SKJ MP <sup>1</sup>	NA
ID/PH/VN (non-AW)	SKJ MP <sup>1</sup>	SKJ MP <sup>1</sup>	SKJ MP <sup>1</sup>	NA
Southern Troll	NA	NA	NA	ALB MP <sup>2</sup>
Archipelagic Waters and Territorial Seas	Aligned to SKJ MP, national plan or local MP	Aligned to SKJ/BET MPs, national plan or local MP	Aligned to SKJ/BET/ALB MPs, national plan or local MP	Aligned to ALB MP, national plan or local MP
Notes	1. Application of SKJ MP to these fisheries could be proportionate to Tropical PS over a specified base period, or subject to a specific allocation decision by WCPFC.	1. Use effort scalar specified by SKJ MP to estimate YFT catch (inc. specified FAD measures). 2. Use effort or catch scalar (maintain spp. comp.) specified by BET MP to estimate YFT catch. 3. Use effort or catch scalar (maintain spp. comp.) specified by ALB MP to estimate YFT catch.	1. Use effort scalar specified by SKJ MP to estimate BET catch (incl. specified FAD measures). 2. Application of BET MP to these fisheries could be proportionate to Tropical LL over a specified base period, or subject to a specific allocation decision by WCPFC. Also possible to align to NP ALB MP. 3. Use effort or catch scalar (maintain spp. comp.) specified by ALB MP to estimate BET catch.	1. In the initial single stock evaluation for SPA, tropical LL is controlled by the SPA MP. For the combined modeling approach, use effort or catch scalar (maintain spp. comp) specified by BET MP to estimate ALB catch. 2. Application of ALB MP to this fishery could be proportionate to southern LL over a specified base period, or subject to a specific allocation decision by WCPFC.

Table 3: Proposed integration of stock-based Management Procedures (MPs) across fisheries under the hierarchical approach. The cells in bold signify the main fishery being controlled by the MP. Options for including other fisheries in the MPs are described in the table footnotes.

scale by the same amount as the tropical purse seine effort. Alternatively, they could be subject to a specific allocation decision by the WCPFC. These fisheries also catch yellowfin and bigeye and this interaction needs to be included when evaluating these stocks, as discussed below. In the initial skipjack evaluations all modelled fisheries, except those in archipelagic waters, are currently controlled by the MP (Scott et al., 2019).

The South Pacific albacore MP is primarily responsible for controlling the southern longline fisheries. The southern troll fisheries could also be controlled by this MP, following a similar proportional approach as described above, or subject to a specific allocation decision by the WCPFC. The southern longline fisheries also catch bigeye and yellowfin which needs to be considered in the evaluations. In the initial South Pacific albacore evaluations all modelled fisheries are currently controlled by the South Pacific albacore MP. However, in the the combined modelling approach described below, the effort or catches of South Pacific albacore of the tropical longline fishery (0-10° South) will be determined by the bigeye MP.

The bigeye MP is primarily responsible for controlling the tropical longline fisheries. The northern longline fishery could also be controlled by this MP, following a similar proportional approach described above or subject to a specific allocation decision by the WCPFC. Alternatively, it may be possible to align the management of the northern longline fishery to the North Pacific albacore harvest strategy. The tropical and northern longline fisheries also catch yellowfin which needs to be considered in the evaluations. The tropical longline fishery (0-10° South) also catches small amounts of South Pacific albacore that would be explicitly considered in the combined modelling framework as described below.

The management of archipelagic waters and territorial seas needs to be defined for the modelling. For example, management could be aligned to the stock MPs, to national plans or could be managed under local MPs. In the current skipjack evaluations archipelagic waters are excluded from the MP and operate under a status quo assumption. We note however that decisions on the management of archipelagic waters and territorial seas are the responsibility of the States concerned.

Within this hierarchical approach, when developing the single stock MPs it will be necessary to include the impacts of fisheries that are under the control of the MPs for other stocks. This mainly affects the development of the MP for bigeye. For example, the bigeye stock is also caught by tropical purse seine fisheries which are controlled by the skipjack MP, and southern longline fisheries which are controlled by the South Pacific albacore MP. An initial approach is that the activity of these fisheries in the relevant regions of the bigeye models can be taken from the skipjack and South Pacific albacore evaluations, using a method similar to that employed for the tropical tuna Conservation and Management Measures (CMM2018-01) evaluations (Pilling et al., 2019). As an initial approach, assumptions could be made about the future fishing activity of the purse seine and southern longline fisheries, for example by sampling from the historical distributions of catches of those fisheries. The primary impact by purse seine fisheries on bigeye is through the associated-set component of the fishery. Under current developments within the skipjack MP, the associated and

unassociated components within the purse seine fishery are assumed to be equally affected by the MP (Scott et al., 2019). For bigeye, therefore, assumptions on how that total effort is distributed between the associated and unassociated purse seine fishery components will need to be made, given the difference in their relative impact on the stock (Figure 9). This might include the approach to modelling the FAD closure (and management guidance on the formulation of any such closure into the future).

This proposed approach means that there is no direct MP for yellowfin, i.e. the stock status of yellowfin is not considered by an MP to set fishing opportunities. Instead, yellowfin will be managed indirectly through the MPs for the other stocks. To evaluate the potential impacts of the three MPs on yellowfin a combined modelling framework is proposed. From the single stock evaluations described above, a subset of prospective MPs, or the (interim) adopted MP where relevant, for skipjack, South Pacific albacore and bigeye can be selected. These can then be used in a combined modelling framework that includes all four stocks and the four fisheries operating in parallel (Figure 2). In this modelling framework, the MP for skipjack and the MP for South Pacific albacore also impact on the yellowfin and bigeye stocks through the fisheries described in Table 3. The MP for bigeye also impacts on the yellowfin and the South Pacific albacore stocks. The combined modelling framework would be used to identify those MP combinations that have an acceptably high chance of achieving management objectives for all stocks, including yellowfin.

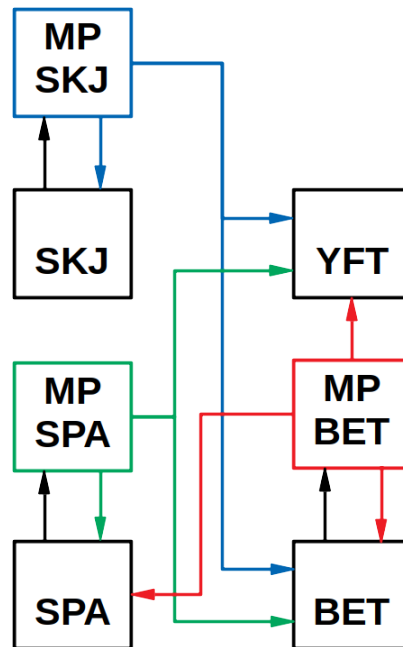

Figure 2: Schematic of the combined modelling framework used in the hierarchical approach. The management procedures (MP) for the different stocks are signified by the different colours. The stocks that are impacted by the different MPs are shown by the connecting coloured lines. For details of which fisheries are being controlled by which MP and impact which stocks see Table 3. The black arrows show the estimated stock status feeding into the MP to set fishing opportunities.

Using this approach it will be possible to calculate a range of performance indicators (PI), including the multi-species performance indicators that have been noted by WCPFC. For example, the probability of the spawning biomass depletion ( $SB/SB_{F=0}$ ) being greater than the limit reference point (LRP) can be calculated for each stock (Yao et al., 2019; Scott et al., 2018b; WCPFC, 2017b,a; OFP, 2017).

The approach of testing a sub-set of the single stock MPs, or the (interim) adopted MP where relevant, constrains the technical analysis to tractable levels. Testing all initial candidate MPs across all three stocks and sources of uncertainty rapidly leads to excessive levels of computational requirement. By narrowing down the MPs at the single species level before evaluating the multi-species/fisheries consequences in the combined modelling framework at a later stage, this issue is reduced (but not eliminated).

This combined modelling framework still has several technical challenges. The choice of mechanism through which the fishery impact on the stock will be controlled by management, e.g. catch or effort limits, has implications for the implementation of the projections (as noted in Table 3). For example, the MP for bigeye may set the future level of tropical longline bigeye catch, rather than its effort. To map that impact onto the yellowfin evaluation, recent work has assumed that a comparable change in tropical longline yellowfin catch might result. However, it would be better to evaluate the equivalent level of tropical longline fishing effort that equates to that bigeye catch, in order to input that effort into evaluations of the impact on the yellowfin stock. In both cases, this would assume limited change in tropical longline targeting.

The PIs from the single stock bigeye evaluation may be different to when they are calculated using the combined modelling framework due to the different way the influence of the purse seine and southern longline fisheries on the bigeye stock is simulated. For this reason, selection of MPs may be re-considered after the evaluations using the combined modelling framework.

The approach described here requires several assumptions that will require input at the Commission level. Assumptions will also need to be made about changes in the distribution of effort within the WCPO fishery. For example, if the MP for South Pacific albacore suggests a reduction in fishing activity in southern longline, assumptions will need to be made about the possible redistribution of effort; i.e. potential increases in tropical or northern longline fishing effort, or the removal of fishing effort from the system.

While this approach captures the potential impact of many of the main fishing gears, when considering yellowfin the activity of the 'other' fisheries that take  $\sim 20\%$  of the yellowfin catch needs to be considered (Table 1). Noting that much of this catch is from small scale gears operating within archipelagic waters, a decision on the feasibility of their inclusion within any management procedure, or assumptions to be made for these fisheries, is needed.

The positives of this hierarchical approach include:

- It allows the multi-stock complexity of WCPO fisheries into a tractable modelling approach;
- The hierarchical decision-making approach is more easily considered by managers;
- The time required to perform the analyses is technically feasible and hence allows the iterative science-management discussions to be maintained.

The disadvantages to this approach include:

- The post-hoc combination of MPs for each stock does not fully capture the interactions between them;
- The status of yellowfin tuna is not directly controlled by its own MP, although the MPs controlling key gear may lead to similar dynamics (which would be tested within the proposed approach);
- The status of bigeye tuna directly informs management for only the tropical and possibly northern longline fisheries, which take 41% of the total bigeye tuna catch.

Decisions will need to be made by the Commission on the fisheries whose activities will be controlled by the MPs, as described in Table 3.

## 4 Discussion

We have identified two approaches to capture the mixed fishery interactions between WCPO fisheries and stocks. Throughout the paper we have concentrated on the technical issues involved in developing this multi-species/multi-fleet framework, consistent with the remit of Scientific Committee. Evaluating the technical issues and trade-offs involved in the different approaches, we view the hierarchical approach to be technically the most tractable while best capturing the interactions required.

While the hierarchical approach does not fully capture mixed fishery/mixed species interactions in a fully integrated framework, it provides an initial step to pursuing the further development of WCPO harvest strategies, which will highlight potential areas for subsequent management focus and inform future model development.

We note that the suggested approach of developing three single stock MPs means that there is no direct MP for yellowfin. Instead, the hierarchical approach evaluates the potential impacts on yellowfin prior to full implementation. To ensure the combined MP results in the yellowfin objectives being met, SC may wish to consider enhanced monitoring of yellowfin stock status, for example, through indicators or more frequent stock assessments.

If the hierarchical approach was pursued within the development of relevant WCPO tuna MPs, the Commission would need to consider the following management aspects within that approach:

- Whether the proposed hierarchical approach is appropriate to capture the multi-species/multi-gear nature of WCPO fisheries;
- How the distribution of effort between the associated and unassociated purse seine sets continued in the future;
- How any displaced effort is dealt with (under the assumption that overall effort remains stable);
- How do PIs noted by WCPFC for multi-species considerations (e.g. biomass based indicators for the stocks) influence the choice of MP?
- The fisheries whose activities are to be controlled by the different MPs, as described in Table 3.

We invite WCPFC-SC15 to consider the following recommendations:

- Consider the technical issues involved in evaluating multi-species/multi-fleet management procedures in the WCPO;
- Consider the above alternative approaches and recommend a preferred approach.

## Acknowledgments

We gratefully acknowledge funding for this work from the New Zealand Ministry of Foreign Affairs and Trade (MFAT) funded project "Pacific Tuna Management Strategy Evaluation".

## References

- Brouwer, S., Pilling, G., Hampton, J., Williams, P., Tremblay-Boyer, L., Vincent, M., Smith, N., and Peatman, T. (2018). The Western and Central Pacific Tuna Fishery: 2017 overview and status of stocks. Tuna Fisheries Assessment Report 18, Secretariat of the Pacific Community – Oceanic Fisheries Programme.
- Fulton, E. A., Link, J. S., Kaplan, I. C., Savina-Rolland, M., Johnson, P., Ainsworth, C., Horne, P., Gorton, R., Gamble, R. J., Smith, A. D. M., and Smith, D. C. (2011). Lessons in modelling and management of marine ecosystems: the atlantis experience. *Fish and Fisheries*, 12(2):171–188.
- Kirchner, C. H., Berger, Banks, R., and Reid, C. (2014). Developing a bioeconomic model for wcpo tuna fisheries to assess potential economic outcomes under alternative management options. WCPFC-SC10-2014/MI-IP-04.
- Norris, W., Reid, C., and SPC-OFP (2013). Trade-offs in Multi-Species, Multi-Gear Fisheries: Second Expert Working Group on Management Objectives, Performance Indicators and Reference Points. Summary report, Commission for the Conservation and Management of Highly Migratory Fish Stocks in the Western and Central Pacific Ocean, Cairns, Australia, 28–29 November 2013.
- OFP (2017). Performance indicators and monitoring strategies for bigeye and yellowfin tuna compatible with candidate management objectives for the tropical longline fishery. WCPFC14-2017-IP04, Manilla, Philippines, 3-7 December 2017.
- Pilling, G., Williams, P., and Hampton, S. (2019). Evaluation of CMM 2018-01 for tropical tuna. WCPFC-SC15-2019/MI-WP-11, Pohnpei, Federated States of Micronesia, 12–20 August 2019.
- Pilling, G. M., Berger, A. M., Reid, C., Harley, S. J., and Hampton, J. (2016). Candidate biological and economic target reference points for the South Pacific albacore longline fishery. *Fisheries Bulletin*, 174:167–178.
- Punt, A. E., Butterworth, D., de Moor, C., De Oliveira, J., and Haddon, M. (2014). Management strategy evaluation: best practices. *Fish and Fisheries*, (DOI:10.1111/faf12104).
- Scott, F., Scott, R. D., Davies, N., Pilling, G., and Hampton, S. (2018a). Technical developments in the MSE modelling framework. WCPFC-SC14-2018/MI-IP-02, Busan, South Korea, 5–13 August 2018.
- Scott, F., Scott, R. D., Pilling, G., and Hampton, S. (2018b). Performance indicators for comparing management procedures using the MSE modelling framework. WCPFC-SC14-2018/MI-WP-04, Busan, South Korea, 5–13 August 2018.



- Scott, F., Scott, R. D., Pilling, G., and Hampton, S. (2019). The WCPO Skipjack MSE Modelling Framework. WCPFC-SC15-2019/MI-IP-02, Pohnpei, Federated States of Micronesia, 12–20 August 2019.
- WCPFC (2015). Agreed work plan for the adoption of harvest strategies under cmm 2014-06. , Twelfth Regular Session of the WCPFC Commission, Bali, Indonesia, 3–8 December 2015.
- WCPFC (2017a). Fourteenth Regular Session of the Commission - Summary Report. , Manilla, Philippines, 3-7 December 2017.
- WCPFC (2017b). Report of the Scientific Committee Thirteenth Regular Session. Technical report, Commission for the Conservation and Management of Highly Migratory Fish Stocks in the Western and Central Pacific Ocean, Rarotonga, Cook Islands, 9–17 August 2017.
- Yao, N., Scott, F., Scott, R. D., Pilling, G., and Hampton, S. (2019). Calculating performance indicators for South Pacific albacore. WCPFC-SC15-2019/MI-WP-10, Pohnpei, Federated States of Micronesia, 12–20 August 2019.

## A Distribution of catches and fisheries for the four tuna stocks

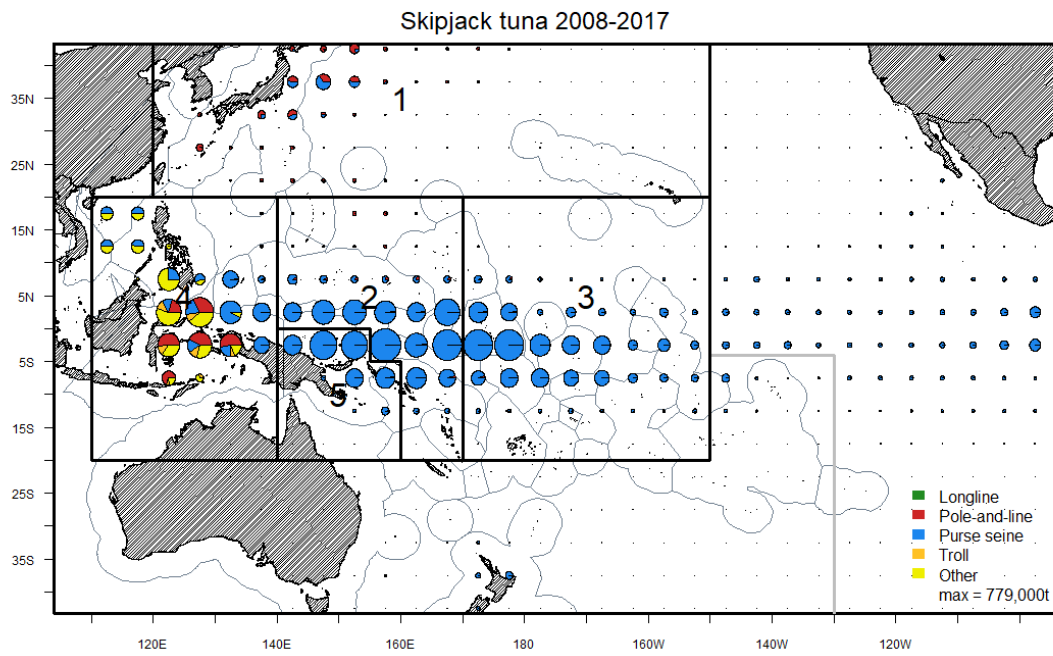

Figure 3: Distribution of catch by fishery for skipjack (from: Brouwer et al. (2018)).

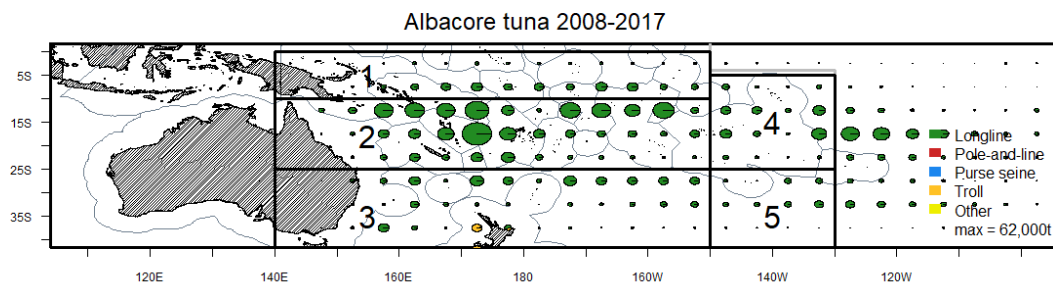

Figure 4: Distribution of catch by fishery for South Pacific albacore (from: Brouwer et al. (2018)).

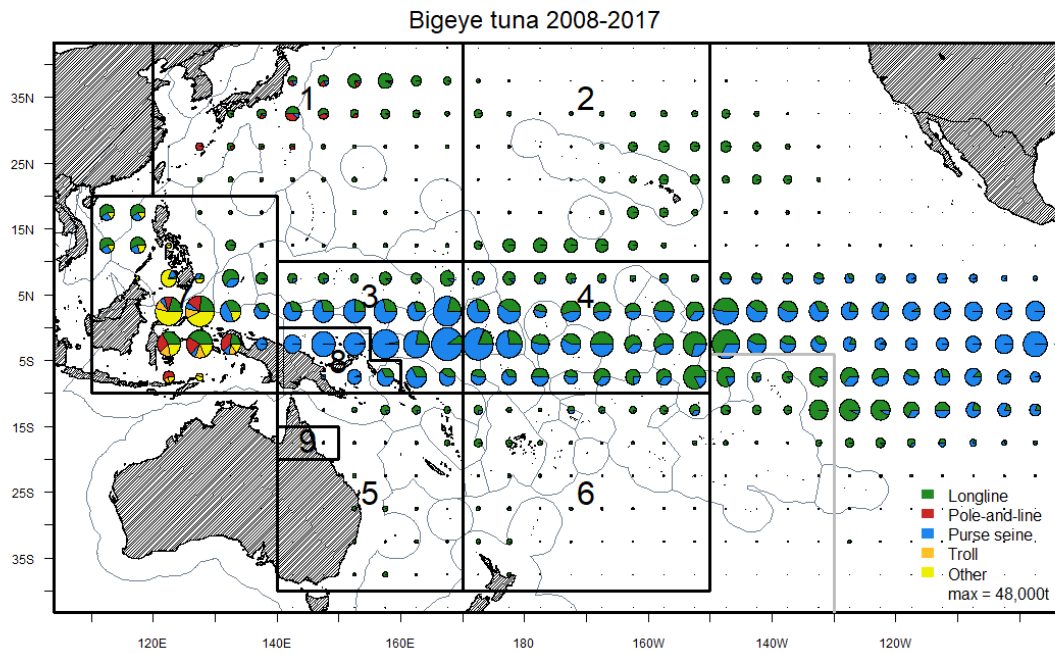

Figure 5: Distribution of catch by fishery for bigeye (from: Brouwer et al. (2018)).

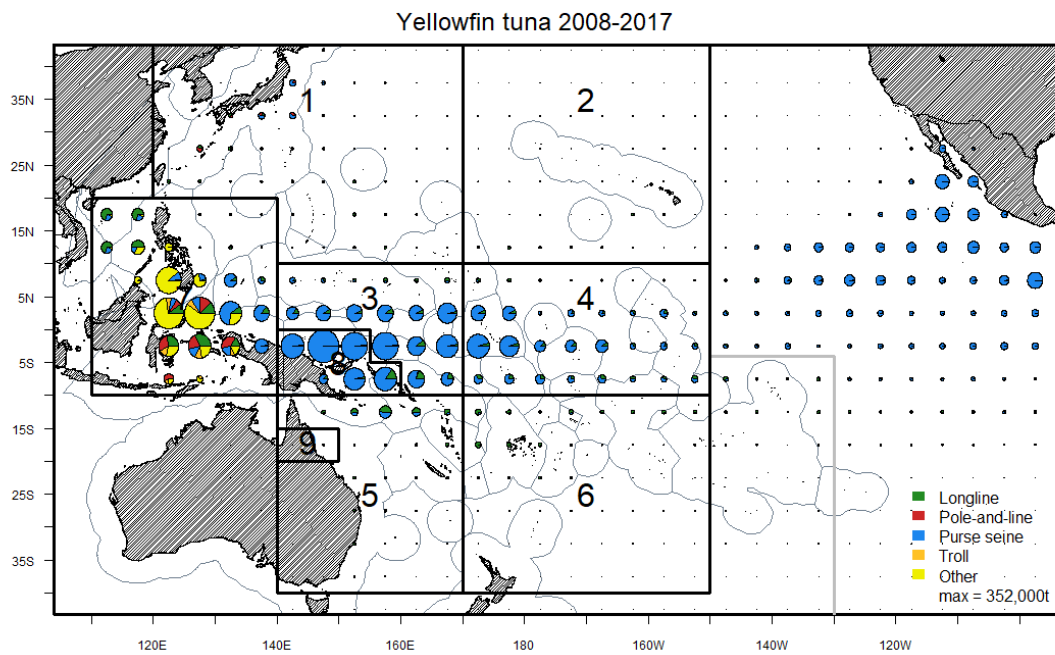

Figure 6: Distribution of catch by fishery for yellowfin (from: Brouwer et al. (2018)).

## B Impact of fisheries on the four tuna stocks

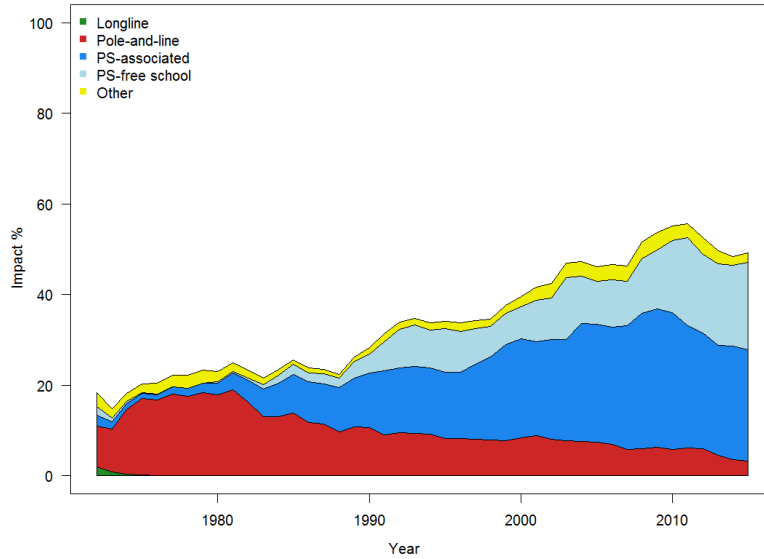

Figure 7: Fishery impact (fishery impact =  $1 - SB_{latest}/SB_{F=0}$ ) on skipjack attributed to various fishery groups across all regions within each diagnostic/reference case model from the most recent assessment.

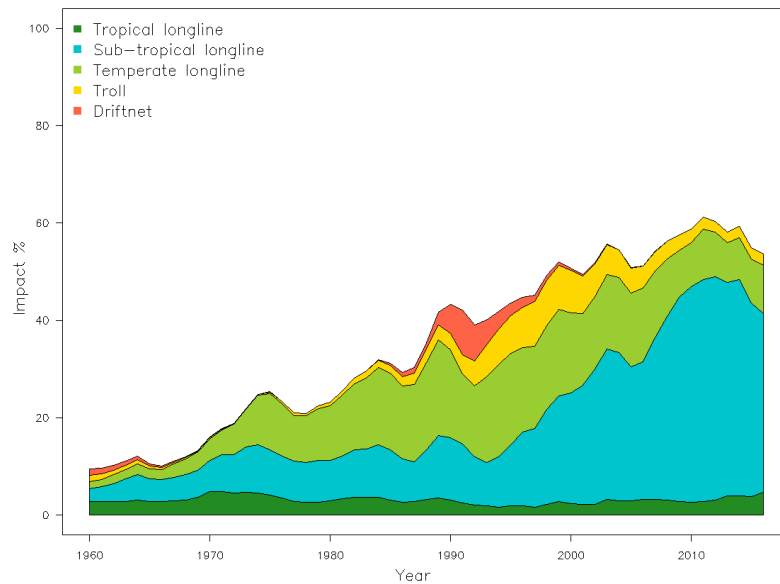

Figure 8: Fishery impact (fishery impact =  $1 - SB_{latest}/SB_{F=0}$ ) on South Pacific albacore attributed to various fishery groups across all regions within each diagnostic/reference case model from the most recent assessment.

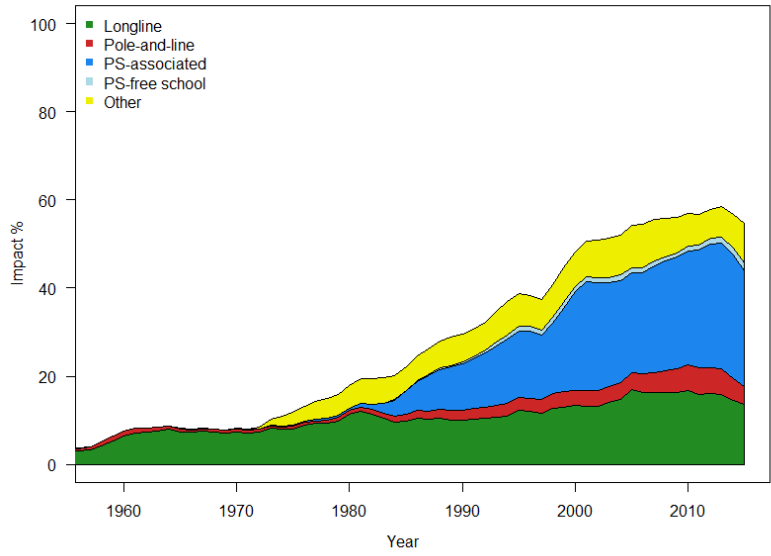

Figure 9: Fishery impact (fishery impact =  $1 - SB_{latest}/SB_{F=0}$ ) on bigeye attributed to various fishery groups across all regions within each diagnostic/reference case model from the most recent assessment.

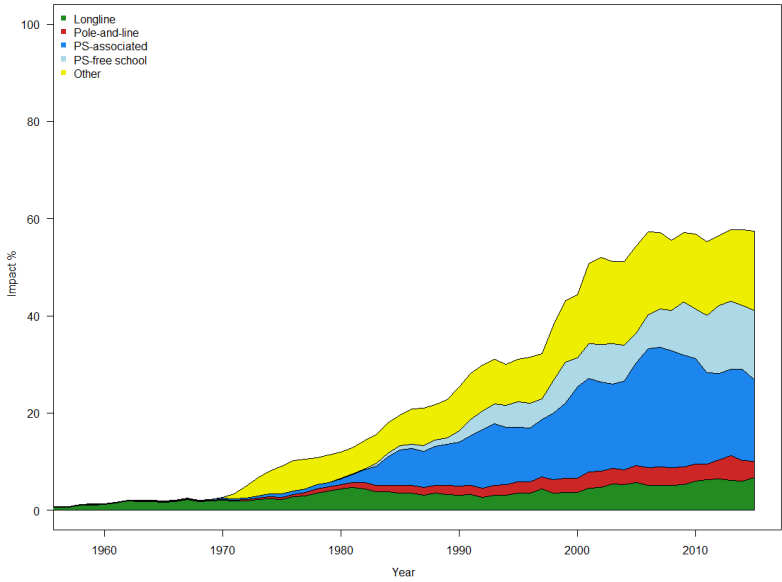

Figure 10: Fishery impact (fishery impact =  $1 - SB_{latest}/SB_{F=0}$ ) on yellowfin attributed to various fishery groups across all regions within each diagnostic/reference case model from the most recent assessment.